



Wheel Accessory Products Catalog

Enhance Appearance and Functionality



Questions about Alcoa® Wheel Accessories

If you have questions about our products, please call 800-242-9898, and a customer service representative will assist you.

Accessory Warranty

This warranty covers all wheel accessories listed in this Accessory Products Catalog and all other wheel accessories sold and/or manufactured by Alcoa Wheels (“Wheel Accessories”). Alcoa Wheels warrants Wheel Accessories to be free from any manufacturing defects for two (2) years from the date of purchase. If a Wheel Accessory is defective at any time during the above described warranty period, the Wheel Accessory shall be returned along with the original receipt and a brief description of the defect to Howmet Wheel Systems, 3320 Gilchrist Rd., Mogadore, Ohio 44260. Upon confirmation that the Wheel Accessory is defective, Alcoa Wheels, shall replace the defective Wheel Accessory. Alcoa Wheels shall have no other liability for breach of warranty. For more information regarding warranty coverage or procedures, please call 800-242-9898 option # 1 to speak with an Alcoa Wheels representative.

This warranty is limited to the original consumer purchaser of the Wheel Accessory and expires immediately upon transfer of the Wheel Accessory to another individual or entity. Alcoa Wheels does not warrant against defects that are caused by misuse or abuse of the Wheel Accessory. ADDITIONALLY, ALCOA WHEELS HEREBY DISCLAIMS ANY AND ALL IMPLIED WARRANTIES, INCLUDING, BUT NOT LIMITED TO ANY WARRANTIES OF MERCHANTABILITY OR FITNESS FOR A PARTICULAR PURPOSE. ALCOA WHEELS IS NOT RESPONSIBLE FOR ANY INCIDENTAL OR CONSEQUENTIAL DAMAGES CAUSED BY THE WHEEL ACCESSORIES. Some states do not allow the exclusion or limitations of incidental or consequential damages, so the above limitations or exclusion may not apply to you. This warranty gives you specific legal rights, and you may also have other rights, which vary from state to state. Nothing in this warranty shall be construed as superseding or adding to any Alcoa Wheels warranty for truck wheels, light truck, wheels, auto wheels or other products.

California Proposition 65 Warning

Pursuant to the California Safe Drinking Water and Toxic Enforcement Act of 1986 (“Proposition 65”), Alcoa Wheels is providing information regarding the presence of a chemical known to the state of California to cause cancer or reproductive toxicity (a “Proposition 65-listed chemical”) in products we sell. This information is being provided to inform customers about the presence of a Proposition 65-listed chemical in products so that they may take additional steps to comply with any applicable Proposition 65 warning requirements for their California employees or end users / consumers in California. Because Alcoa Wheels does not have knowledge of or control over the various ways in which our products may be used in the manufacture of consumer products that are sold or supplied in California or in occupational settings in California, we make no determination as to whether our products may result in an exposure requiring a warning under Proposition 65 to individuals in California. However, if manufacturers or distributors determine that a Proposition 65 warning is required based on the anticipated uses of Alcoa Wheels products, or other products which may be composed in part of Alcoa Wheels products, such warning should be provided consistent with the Article 6 Clear and Reasonable Warnings regulation, 27 C.C.R. § 25600 et. seq. Specific products that contain chemicals known to the State of California to cause cancer and birth defects or other reproductive harm can be found at <https://www.alcoawheels.com/alcoawheels/north-america/en/california-prop-65-warning.asp>.

Service Manual For Alcoa Wheels

This limited warranty should be used in conjunction with the Service Manual For Alcoa Wheels. The Service Manual For Alcoa Wheels contains important safety information and warnings, and failure to read and understand this information may result in serious injury or death. The limited warranty is included with the Wheel Service Manual, but may appear elsewhere. If you do not have copies of the Service Manual For Alcoa Wheels, you may obtain copies free of charge from Howmet Wheel Systems, 1616 Harvard Avenue, Cleveland, Ohio 44105, (800) 242-9898 and on the Web and at www.alcoawheels.com.

¹ The Alcoa trademarks are owned by Alcoa USA Corporation and used by Howmet Aerospace Inc. and its subsidiaries under license from Alcoa USA Corporation.

 The Starburst design is a registered Trademark Howmet Aerospace Inc.





Table of Contents

Heavy Duty Applications - Appearance

- New One-Piece Hub Cover System with Secure Fit Retention..... 3
- Classic One-Piece Hub Cover System.....4
- Multi-Piece Hub Cover Systems 5-6
- Hug-A-Lug® Nut Covers 7-8

Heavy Duty Applications - Wheel Nuts and Valves

- Wheel Cap Nuts (Fasteners) 9-10
- Valve Stems 11
- Valve Stem Extension Stabilizer Kits..... 12
- Valve Stem Extensions 12
- Valve Stem Extension Stabilizers..... 13

Heavy Duty Applications - Maintenance

- Service Gauges 14
- Air Chucks..... 14
- Double Seal Valve Caps 14
- E-Z Mount Wheel Alignment Sleeves 15
- Rim Flange Wear Gauges 15

Medium Duty Applications - Appearance

- Hub Cover Kits.....16-18
- Aluminum Axle End Covers..... 19-20
- Hug-A-Lug® Nut Covers 21

Medium Duty Applications - Wheel Nuts

- Two-Piece Flange Nuts22
- Wheel Cap Nuts (Fasteners)22



Starburst design indicates application guidelines and other details on how to use our products.



One-Piece Hub Cover System with Secure Fit Retention

Part No.	Description	Wheel Type	Finish
o88100S	Front Axle Kit includes: Two front covers, ten retention nuts, and one removal tool. Requires a minimum of 3 threads per stud. Maximum stud standout 3".	Hub Pilot for 10-Hole, 285.75mm, 22.5" and 24.5" Wheels	Chrome
o89100S	Rear Axle Kit includes: Two rear covers, ten retention nuts, and one removal tool. Requires a minimum of 3 threads per stud. Maximum stud standout 4".	Hub Pilot for 10-Hole, 285.75mm, 22.5" and 24.5" Wheels	Chrome
o88100S - BLK	Front Axle Kit includes: Two front covers, ten retention nuts, and one removal tool. Requires a minimum of 3 threads per stud. Maximum stud standout 3".	Hub Pilot for 10-Hole, 285.75mm, 22.5" and 24.5" Wheels	Black
o89100S - BLK	Rear Axle Kit includes: Two rear covers, ten retention nuts, and one removal tool. Requires a minimum of 3 threads per stud. Maximum stud standout 4".	Hub Pilot for 10-Hole, 285.75mm, 22.5" and 24.5" Wheels	Black

 **Hand tighten retention nuts over studs in a triangular pattern so that they align with three of the five inner retention cylinders underneath the lug nut features of the hub cover. Use a short handle rubber mallet to secure the cover over the retention nuts. A slight gap of 2mm will be seen due to improved standoff design.**

New! Improved Retention. Fits More Applications.

- Improved secure fit retention system provides consistent contact points for cover
- Maintains convenient one-piece design
- Taller nut towers accommodate increased stud standout and ensure systems fits more applications
- Improved standoff design preserves wheel finish





086100S



087100S



000800
(included in kit)

Classic One-Piece Hub Cover System

Part No.	Description	Wheel Type	Finish
086100S	Front Axle Kit includes: Two front covers and one removal tool. Use a short handle rubber mallet for application. Maximum stud stand out 2.50".	Hub Pilot for 10-Hole, 285.75mm, 22.5" and 24.5" Wheels	Chrome
087100S	Rear Axle Kit includes: Two rear covers, six retention nuts, and one removal tool. Use a short handle rubber mallet for installation. Maximum stud stand out 2.50".	Hub Pilot for 10-Hole, 285.75mm, 22.5" and 24.5" Wheels	Chrome



Use when you have less than three stud threads available above the lug nut. Cap will contact the wheel when fully installed.

It's a One-Piece Wonder!

- Clamps directly to lug nuts ensuring compatibility with flush nut configurations
- Easy on-off attachment system
- Reduces parts inventory for dealership
- Proven design

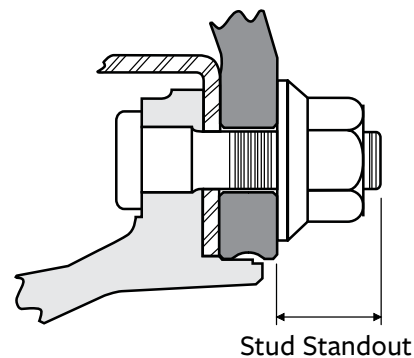

Stud stand out is the distance from the wheel to the end of the stud with the wheel securely mounted.



077188

076188

Multi-Piece Hub Cover System with Clamp-on Hug-A-Lugs®

Part No.	Description	Wheel Type	Nut Cover
076188	Front Hub Cover Kit includes: One hub cover, 10 Hug-A-Lugs® with clamps and one wrench. Cover secured by screwing 001881 onto inner clamp placed on hex nut. Max. stud stand-out 2.32".	Hub Pilot for 10-Hole, 285.75mm, 22.5" and 24.5" Wheels	001881 (clamp) 33mm
077188	Rear Hub Cover Kit Includes: One hub cover, 10 Hug-A-Lugs® with clamps and one wrench. Cover secured by screwing 001881 onto inner clamp placed on hex nut. Max. stud stand-out 2.32".	Hub Pilot for 10-Hole, 285.75mm, 22.5" and 24.5" Wheels	001881 (clamp) 33mm



Use this clamping Hug-a-Lug® stud attachment system when you have less than 4 stud threads available above the lug nuts.

Classic, Multi-Piece Styling for that Traditional Look

- Classic 11-Piece Design
- Highly reflective superior finish
- 2-year warranty
- Designed for hub piloted wheels
- Available in front and rear applications

Select the Appropriate Kit for Your Application

Easy to install and maintenance free, these kits are available in two Hug-A-Lug® attachment systems depending on stud threads available above the lug nut.



076185

077185

Multi-Piece Hub Cover System with Stud-Gripping, Screw-on Hug-A-Lugs®

Part No.	Description	Wheel Type	Nut Cover
076185	Front Hub Cover Kit includes: One hub cover, 10 screw-on Hug-A-Lugs® and one wrench. Cover secured by screwing 001851 directly onto stud threads. Max. stud stand out 2.30". Requires a minimum of 4 threads per stud.	Hub Pilot for 10-Hole, 285.75mm, 22.5" and 24.5" Wheels	001851 (screw-on) 33mm
077185	Rear Hub Cover Kit Includes: One hub cover, 10 screw-on Hug-A-Lugs® and one wrench. Cover secured by screwing 001851 directly onto stud threads. Max. stud stand out 2.30". Requires a minimum of 4 threads per stud.	Hub Pilot for 10-Hole, 285.75mm, 22.5" and 24.5" Wheels	001851 (screw-on) 33mm

Use this stud-gripping, screw-on Hug-A-Lug® attachment and system to secure the center axle cover when you have 4 or more threads available above the lug nut.

For technical assistance with identifying the correct product for your heavy duty truck, call 800.242.9898



Components for Multi-Piece Hub Cover Systems



Hub Covers

Part No.	Description	Finish
076100	Front Axle Cover for Multi-Piece Hub Cover System	Chrome
077100	Rear Axle Cover for Multi-Piece Hub Cover System	Chrome



Hug-A-Lug® Nut Covers for 33mm Hex Two-Piece Flange Nuts (Hub Pilot Wheels)

Part No.	Description	For Nut Heights	Maximum Stud Standout	Finish
001851	For 33mm Hex Two-Piece Flange Nut for Trucks (screw-on)	27-31mm	2.30"	Chrome
001881	For 33mm Hex Two-Piece Flange Nut for Trucks (clamp-on)	27-31mm	2.32"	Chrome
000188	Black Interlocking Clamp (replacement)	27-31mm		
000888	Off-White Interlocking Clamp (replacement)	27-31mm		

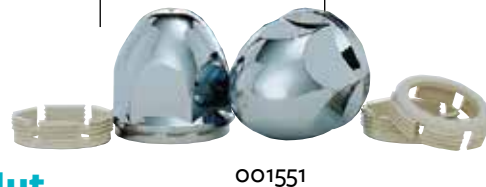

Hug-A-Lug® Nut Covers for 1.5" Hex Nut (Ball Seat Wheels)

Part No.	Description	Maximum Stud Standout	Finish
001551	For 1.5" Hex Ball Seat Nut, with clamps	1.91"	Chrome
000155	White Interlocking Clamps (replacements)		
000555	Gray Interlocking Clamps (replacements)		

Hub Cover System Hug-A-Lug® Nut Cover Wrenches

Part No. Single	Part No. Shelf Pack (5)	Description
000500	000500SP	Cap Nut Cover Wrench for Ball Seat Hug-A-Lugs®, for 001551
000600	000600SP	Cap Nut Cover Wrench for Hub Piloted Hug-A-Lugs®, for 001851 and 001881



Hug-A-Lug® Two-Piece Nut Covers for 33mm Hex Flange Nuts

(Hub Pilot Wheels)

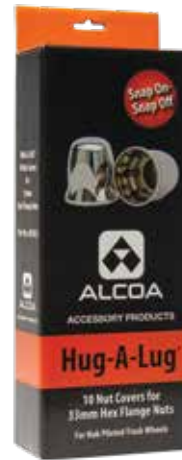

001811

Part No. Single	Part No. Shelf Pack (10)	Part No. Display Pack (10)	Description	Maximum Stud Standout	For Nut Heights	Finish
001801	001802	-	For 33mm Hex Flange Nut for Buses	1.95"	.886" - 1.0"	Chrome
001811	001812	001813	For 33mm Hex Flange Nut for Trucks	1.95"	27-31mm	Chrome

Hug-A-Lug® Nut Covers for 1.5" Hex Two-Piece Flange Nuts

(Hub Pilot Wheels)

Part No. Single	Part No. Shelf Pack (10)	Description	Maximum Stud Standout	For Nut Heights	Finish
001821	001822	For 1.5" Hex Flange Nut for Trucks	2.20"	1.4375"	Chrome

Hug-A-Lug® Nut Covers for 1.5" Hex Nut

(Ball Seat, Stud Located Wheels)

Part No. Single	Part No. Shelf Pack (10)	Description	Maximum Stud Standout	Finish
001501	001502	For 1.5" Hex Stud-pilot Nut	1.87"	Chrome

Wheel Cap Nuts (Fasteners) Outer Cap Nuts (For Two-Piece Flange Nuts - Hub Pilot Wheels)



039874

Part No. Single	Part No. Shelf Pack (10)	Description
039874	039874SP	Two-piece, 26.25mm height, 33mm hex, M22 x 1.5mm, RH thread flange nut. Mounts single and dual aluminum wheels with 26mm bolt holes to wheel centering hubs. Right-hand threads used on both sides of vehicle.



617736

Part No. Single	Part No.	Description
617722		Geomet coated. Two-piece, 32.5mm height, 33mm hex, M22 x 1.5mm, RH thread, sleeved cap nut. Mounts single aluminum wheels with 32mm bolt holes, to wheel centering hubs with stud standouts less than 1.71" (43.5mm). Right-hand threads used on both sides of vehicle. Inserts (INSM22) included.
617736		Geomet coated. Two-piece, 46mm height, 33mm hex, M22 x 1.5mm, RH thread, sleeved cap nut. Mounts either single or dual aluminum wheels with 32mm bolt holes, to wheel centering hubs with stud standouts less than 2.85" (72mm). Right-hand threads used on both sides of vehicle. Inserts (INSM22) included.



430632

Part No. Single	Part No. Shelf Pack (10)	Description
430632	430632SP	Phos and oil coated. Two-piece, 50mm height, 33mm hex, M22 x 1.5mm, RH thread, sleeved cap nut. Mounts single aluminum wheels, with 32mm bolt holes, to wheel centering hubs with stud standouts less than 1.71" (43.5mm). Right-hand threads used on both sides of vehicle.
430732	430732SP	Phos and oil coated. Two-piece, 78.5mm height, 33mm hex, M22 x 1.5mm, RH thread, sleeved cap nut. Mounts dual aluminum wheels, with 32mm bolt holes, to wheel centering hubs with stud standouts less than 2.85" (72mm). Right-hand threads used on both sides of vehicle.



430732



To ensure correct mounting with sleeved nuts, there must be enough thread engagement with the stud in accordance with SAE J694 JUN2020 recommended practice: the recommended length of engagement between the threads of the stud and the sleeved nut is equivalent to 95% or more of the diameter of the stud. For Alcoa Wheel sleeved M22x1.5 nuts this equates to 14 full turns (engaged threads) with a minimum 7 threads extending above the face of the wheel that will engage the body of the nut.

Wheel Cap Nuts (Fasteners) Outer Cap Nuts (Ball Seat Wheels)

Part No.	Description	Kit (contains 6 each of)
499100	Complete truck kit – metric medium duty aluminum wheel ball seat mounting kit – M20/1.5 stud thread size, dual aluminum rear wheels kit	499211 left cap nut front, 499222 right cap nut front, 499331 left inner cap nut rear, 499342 right inner cap nut rear, 499451 left cap nut rear, 499462 right cap nut rear

Part No. Single	Part No. Shelf Pack (10)	Thread Direction	Description
499211	499211SP	Left	M20x1.5 cap nut – mounts front single ball seat wheels.
499222	499222SP	Right	
599501	599501SP	Left	3/4" x 16 cap nut – mounts standard single wheels and wide base wheels to 3/4" studs.
599502	599502SP	Right	



599502

Part No. Single	Part No. Shelf Pack (10)	Thread Direction	Description
499451	499451SP	Left	M30x1.5 – mounts double ball seat aluminum wheels in conjunction with inner cap nut, secures outer dual.
499462	499462SP	Right	
599601	599601SP	Left	1 1/8" x 16 cap nut – mounts standard single wheels and wide base wheels to 1 1/8" studs and provides additional 1/8" hex height. Also mounts outer dual wheel to 1 1/8" inner cap nut.
599602	599602SP	Right	



599601

Inner Cap Nuts (Ball Seat Wheels)

Part No. Single	Part No. Shelf Pack (10)	Thread Direction	Description
499331	499331SP	Left	M20/M30x1.5 – for use with dual aluminum ball seat wheels. Secures inner dual in conjunction with outer cap nut
499342	499342SP	Right	
598801	598801SP	Left	For use with standard length studs (1.31" to 1.44" stud standout) or longer studs not to exceed 1.88" stud standout. Full external threads, counter bore 5/16" deep at open end. For use with aluminum inner and outer wheels. Prevents stud from bottoming out in cap nut.
598802	598802SP	Right	



598801



007007
(70MS07)

Grommet Seal Valve Stems

Part No.	Valve No.	A or C Height	Bend Angle	B Length
005401	54MS00	2.12"	–	–
005520	552	1.26"	–	–
005530	553	2.31"	–	–
005533	553C	.93"	45°	1.38"
005535	553E	.98"	75°	1.38"
005544	554D	.98"	60°	1.94"
005554	555D	.98"	60°	2.6"
005555	555E	.98"	75°	2.6"
007007	70MS07	1.59"	7°	1.12"



It is recommended that valve stems be changed at every tire change. See Service Manual For Alcoa Wheels for replacement instructions. Valve numbers 552, 554D, 555D are also available in a black finish for use with Alcoa® Dura-Black Wheels.

Grommet Seal Valve Stem Features

- Longer sealing life
- Greater corrosion resistance
- Larger sealing surface
- Grommet has better temperature range and tear resistance

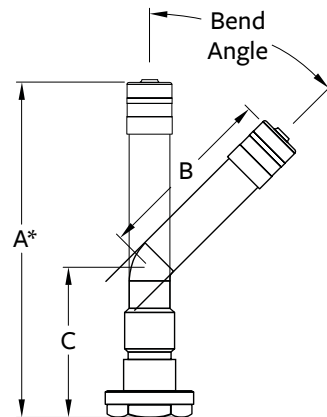

* Height A is used in place of C when valve stem has no bend angle.





864392

Valve Stem Extension Stabilizer Kits

Part No.	Description	Stabilizer (2)	Extensions (2)
ULTRAKT	For ULTRAx wheels with 2.6" diameter hand hole, valve stem diameter 0.33", off-center hole	ULTRASTB	000392
225392	For 87140x, 87240x, 87340x, 87360x, 88311x, 88361x wheels with 2.00" diameter hand hole, stem diameter 0.33", center hole	002225	000392
227392	For 22.5" wheels with 2.50" diameter hand hole, stem diameter 0.33", center hole	002227	000392
864392	For 88267x and 88367x wheels with 2.50" diameter hand hole, stem diameter 0.33", off-center hole	008864	000392
927245	For 98U63x wheels with 2.50" diameter hand hole, stem diameter 0.33", off-center hole	027245	000392



Each kit is designed to fit a specific wheel family. By using the correct valve stem extension and stabilizer, checking tire pressure or adding air is as easy to do on the inside positions as on the outside positions.



000392

Valve Stem Extensions

Part No. Single	Part No. Shelf Pack (10)	Description	Collar Type	Effective Length
000352	000352SP	Valve Stem Extension (Plastic)	Long 1"	5.21"
000392	000392SP	Valve Stem Extension (Metal)	Long 1"	5.125"



Valve Stem Extension Stabilizers

Part No. ULTRASTB
Part No. ULTRASTBSP
 (Shelf Pack 8)



Fits wheel size: 22.5"
 For ULTRAx
 Hand Hole Diameter: 2.6"
 Hole Position: Off-Center

Part No. 002126



Fits wheel size: 19.5"
 For 77349x, 77362x
 Hand Hole Diameter: 1.50"
 Hole Position: Off-Center

Part No. 002127



Fits wheel size: 17.5"
 For 66307x
 Hand Hole Diameter: 1.50"
 Hole Position: Center

Part No. 002225



Fits wheel size: 22.5"
 For 87140x, 87240x, 87340x, 87360x,
 88311x, 88361x
 Hand Hole Diameter: 2.00"
 Hole Position: Center

Part No. 002245



Fits wheel size: 24.5"
 For 98361x, 98565x
 Hand Hole Diameter: 2.19"
 Hole Position: Off-Center

Part No. 002247
Part No. 002247SP
 (Shelf Pack 10)



Fits wheel size: 24.5"
 For 98312x
 Hand Hole Diameter: 2.38"
 Hole Position: Off-Center

Part No. 008864
Part No. 008864SP
 (Shelf Pack 8)



Fits wheel size: 22.5"
 For 88267x and 88367x
 Hand Hole Diameter: 2.50"
 Hole Position: Off-Center

Part No. 008964
Part No. 008964SP
 (Shelf Pack 8)



Fits wheel size: 22.5"
 For 89U64x
 Hand Hole Diameter: 2.00"
 Hole Position: Off-Center

Part No. 027245
Part No. 027245SP
 (Shelf Pack 8)



Fits wheel size: 24.5"
 For 98U63x
 Hand Hole Diameter: 2.70"
 Hole Position: Off-Center



Service Gauges

Part No. Single	Part No. Shelf Pack (5)	Calibration	Incre.	Bar	Chuck Style	Finish
001605	001605SP	10-150 PSI	2 PSI	Nylon	Straight-on	Black
001805	-	10-150 PSI	2 PSI	Nylon	Straight-on	Chrome



The comfortable padding on these gauges allows a positive grip during inclement weather conditions and serves as a protective cushion should the gauge be inadvertently dropped.



Air Chucks

Part No.	Description
003500	Design offers durability and is user friendly on the straight-on and 30° reverse angle chuck. This 6" long chuck finished with an attractive black polyurethane coating has 1/4" NPT female threads.
003700	A special air chuck with a straight-on connection and a 180° reverse chuck allows easier access to valves located in tight, hard-to-reach places. The 003700 is 6" long and has 1/4" NPT female threads.



Valve Caps and Remover

Part No. Single	Part No. Shelf Pack (10)	Description
001009	001009SP	Double seal valve cap seals at the top of the cap which prevents dirt and water from penetrating the cap, eliminating the chances of clogged air passages due to ice and debris. Allows for inflation and deflation of the tire without removing the cap. A great time saver.
000633	-	Valve cap remover makes it easy to remove and install valve caps on inside dual wheels. Designed for aluminum wheels with small hand holes, it comes with a protective sleeve to prevent scratching. Also works great at removing tight or cross-threaded caps. Positive hold while valve is serviced. Keeps cap in tool.

E-Z Mount Wheel Alignment Sleeves

(For Steer, Drive and Trailer Axle Applications with a 22mm Diameter Stud)

Part No.	Description
000426	Individual Wheel Alignment Sleeve
407422	Wheel Alignment Sleeve Kit (2 sleeves)

 **Alcoa Wheels E-Z Mount Wheel Alignment Sleeves play a key role in improving the wheel mounting process and work on steer, drive, and trailer axle applications with a 22mm diameter stud.**

- Align wheel bolt holes
- Seat brake drums that have .908 diameter bolt holes
- Prevent thread damage to M22x1.5 studs
- Assist in lining up all components for ease of install



Rim Flange Wear Gauge

Part No.	Description
000700	Tool used to identify rim flange wear

 **Refer to Service Manual For Alcoa Wheels for additional information and usage guidelines to determine rim flange wear.**





Hub Cover System Kit for Sprinter 3500 Chassis (25180x wheels)

Part No.	Description	Bolt Circle	Finish
021135	Front Axle Kit includes: Two front hub covers (21000) and 12 lug nut covers (000135).	6 x 205mm	Stainless Steel
022135	Front Axle Kit includes: Two rear hub covers (22000) and 12 lug nut covers (000135).	6 x 205mm	Stainless Steel

 For RVs and other applications that use the Sprinter 3500 chassis, place cover over hub and push nut covers over OEM lug nuts.



Wheel Hub Cover System for 8-Hole, 275mm, 17.5" and 19.5" Wheels (66348x, 76542x, 77349x wheels)

Part No.	Description	Bolt Circle	Finish
008201	Front Hub Cover Kit for 30mm Hex Flange Nuts includes: One front hub cover and 8 lug nut covers (000200).	8 x 275mm	Chrome
008202	Rear Hub Cover Kit for 30mm Hex Flange Nuts includes: One rear hub cover and 8 lug nut covers (000200).	8 x 275mm	Chrome
082012	Front and Rear Axle Kit for 30mm Hex Flange Nuts includes: Two front hub covers, two rear hub covers, and 32 lug nut covers (000200).	8 x 275mm	Chrome
008221	Front Hub Cover Kit for 33mm Hex Flange Nuts includes: One front hub cover and 8 lug nut covers (000220).	8 x 275mm	Chrome
008222	Rear Hub Cover Kit for 33mm Hex Flange Nuts includes: One front hub cover and 8 lug nut covers (000220).	8 x 275mm	Chrome
082122	Front Axle Kit for 33mm Hex Flange Nuts includes: Two front hub cover and 16 lug nut covers (000220).	8 x 275mm	Chrome
082133	Rear Axle Kit for 33mm Hex Flange Nuts includes: Two rear hub cover and 16 lug nut covers (000220).	8 x 275mm	Chrome

 Requires a minimum of three threads per stud. Place cover over hub and secure with nut covers. Black spacer not applicable with short lug nut. Grey boxes above represent kits for 30mm hex flange nuts. Center cap removes for easy access to hub.

Wheel Hub Cover System for 8-Hole, 275mm, 17.5" and 19.5" Wheels

(66348x, 76542x, 77349x wheels)



001402



001109

Part No.	Description	Bolt Circle	Finish
001402	Front Hub Cover Kit includes: One front hub cover.	8 x 275mm	Stainless Steel
140230B	Front Axle Kit for 30mm Hex Flange Nuts includes: Two front hub cover and 16 lug nut covers (000230).	8 x 275mm	Stainless Steel
140233	Front Axle Kit for 33mm Hex Flange Nuts includes: Two front hub cover and 32 lug nut covers (000233).	8 x 275mm	Stainless Steel
140233A	Front Axle Kit for 33mm Hex Flange Nuts includes: Two front hub cover and 16 lug nut covers (000233).	8 x 275mm	Stainless Steel



Use when no stud threads are available. Place cover over hub and push nut covers over lug nuts. Grey boxes above represent kits for 30mm hex flange nuts.

Part No.	Description	Bolt Circle	Finish
001109	Rear Hub Cover Kit includes: One rear hub cover, one bolt (001763), and one bracket (001834).	8 x 275mm	Stainless Steel
109176	Rear Axle Kit includes: Two rear hub covers kits (001109).	8 x 275mm	Stainless Steel
109176A	Rear Axle Kit for 33mm Hex Flange Nuts includes: Two rear hub cover kits and 16 lug nut covers (000233).	8 x 275mm	Stainless Steel
109176B	Rear Axle Kit for 30mm Hex Flange Nuts includes: Two rear hub cover kits and 16 lug nut covers (000230).	8 x 275mm	Stainless Steel



Use when no stud threads are available. Secure cover with bracket and bolt system, and push nut covers over lug nuts. Grey boxes above represent kits for 30mm hex flange nuts.

Wheel Hub Cover System for 10-Hole, 225mm, 19.5” Wheels (76329x wheels)



001004









001005

Part No.	Description	Bolt Circle	Finish
001004	Front Hub Cover Kit includes: One front cover, fits Ford F-450 and F-550 (Model Year 2005-2016)	10 x 225mm	Chrome
001005	Rear Hub Cover Kit includes: One rear cover, fits Ford F-450 and F-550 (Model Year 2005-2016)	10 x 225mm	Chrome
001006	Front Hub Cover Kit includes: One front cover, fits Ford F-450 and F-550 (Model Year 2017+)	10 x 225mm	Chrome
001007	Rear Hub Cover Kit includes: One rear cover, fits Ford F-450 and F-550 (Model Year 2017+)	10 x 225mm	Chrome
100450	Hub Cover Axle Kit includes: Two front covers (001004) and two rear covers (001005), fits Ford F-450 and F-550 (Model Year 2005-2016)	10 x 225mm	Chrome
100455	Hub Cover Axle Kit includes: Two front covers (001006) and two rear covers (001007), fits Ford F-450 and F-550 (Model Year 2017+)	10 x 225mm	Chrome



Use the table above to identify the appropriate accessories for your vehicle by model year. Both sets of covers – whose exteriors are identical – secure by snapping on over OEM lug nuts and the hub. Use of the incorrect hub may result in accessory detachment during use.

Aluminum Axle End Covers for 8-Hole, 6.5", 16" and 17.5" Wheels (Hub Pilot Wheels)

<p>Part No. 001611</p>  <p>Height: 1.125" straight For Dodge/Ford dualie applications Bolt Pattern: 8 x 6.50" Fits 16028x (rear), 66140x (front/rear)</p>	<p>Part No. 001612</p>  <p>Height: 4.750" straight For Dodge/Ford dualie applications Bolt Pattern: 8 x 6.50" Fits 16028x (rear), 66140x (front/rear)</p>	<p>Part No. 001613</p>  <p>Height: 3.50" straight For Dodge/Ford dualie applications Bolt Pattern: 8 x 6.50" Fits 66140x (front/rear)</p>
<p>Part No. 001681</p>  <p>Height: 4.750" straight with 3.50" open end For Dodge/Ford dualie applications Bolt Pattern: 8 x 6.50" Fits 16028x (front), 66140x (front/rear)</p>	<p>Part No. 003611</p>  <p>Height: 1.125" straight For Chevy dualie applications Bolt Pattern: 8 x 6.50" Fits 16021x (front)</p>	<p>Part No. 003612</p>  <p>Height: 4.750" straight For Chevy dualie applications Bolt Pattern: 8 x 6.50" Fits 16021x (rear)</p>
<p>Part No. 003613</p>  <p>Height: 3.50" straight For Chevy dualie applications Bolt Pattern: 8 x 6.50"</p>	<p> Mount from the front when installing wheels. Use lug nuts P/N x39xxx to secure to end cover. Refer to the Product Literature section of our website for installation instructions.</p> 	

Aluminum Axle End Covers for 8-Hole, 6.5", 16" Wheels (Cone Seat Wheels)

<p>Part No. 003167</p>  <p>Height: 4.700" straight Hub bores: 5.150" Bolt Pattern: 8 x 6.50" Fits 16704x (front/rear)</p>	<p>Part No. 004167</p>  <p>Height: 4.000" straight Hub bores: 5.150" Bolt Pattern: 8 x 6.50" Fits 16704x (front/rear)</p>	<p> Mount from the rear by pushing through the hub bore when installing wheels.</p>
---	---	---

Axle End Cover Kits for 16028x and 66140x Wheels

Part No.	Description	Finish
110413	Hub Cover Axle Kit includes: Two axle end covers (001611) and 16 Hug-a-Lug® nut covers (019001)	Aluminum (end covers) and chrome (nut covers)
110414	Hub Cover Axle Kit includes: Two axle end covers (001681) and 16 Hug-a-Lug® nut covers (019001)	Aluminum (end covers) and chrome (nut covers)
110416	Hub Cover Axle Kit includes: Two axle end covers (001612) and 16 Hug-a-Lug® nut covers (019001)	Aluminum (end covers) and chrome (nut covers)

Axle End Cover Kits for Ford Transit 350HD (26180x wheels)

Part No.	Description	Package Includes
24019	Hub Cover Kit includes: One axle end cover (front/rear compatible), and 6 Hug-a-Lug® nut covers (019001)	Hub cover, 6 - (019001) Hug-A-Lug® nut covers



24019



Hug-A-Lug® Nut Covers

(For 16", 17.5", and 19.5" Wheels)

Part No.	Description	For Heights	Fits Nuts	Finish
000078*	2.125" Tall	.96"	60° Cone	Chrome
000079*	1.525" Tall	.96"	60° Cone	Chrome
019001**	Hug-A-Lug®	1 1/16"	2-Piece Flange	Chrome

* Fits Alcoa Part No. xx5xxx Nuts

** Fits Alcoa Part No. x39xxx Nuts

Medium Duty Nut Covers

Part No.	Description	Finish
000135	For use with 16", 6-lug Hub Piloted, 205mm Bolt Circle	Chrome
000230	For use with medium duty trucks with 17.5" and 19.5", 8-lug wheels and 30mm hex	Stainless Steel
000233	For use with medium duty trucks with 17.5" and 19.5", 8-lug wheels and 33mm hex	Stainless Steel



 Push on over lug nut to secure.

Flange Nut Covers

Part No.	Description	Finish
000200	30mm Hex Flange Nut	Chrome
000220	33mm Hex Flange Nut	Chrome



 Used to secure multipiece kits 008201, 008202, 008221, and 008222. Requires a minimum of three threads per stud. Black spacer not applicable with short lug nut.



139698



Two-Piece Flange Nuts

(For Hub Pilot 16" and 17.5" Wheels & some RV Wheels)

Part No. Single	Part No. Shelf Pack (10)	Thread Size	Torque
139698	139698SP	M14 x 1.5mm (internal thread), 1.050" hex	140 ft. lbs.
139987	139987SP	9/16" x 18 tpi (internal thread), 1.050" hex	140 ft. lbs.



Each lug nut has specific inner threads for each application and common hex head to accept the Alcoa chrome-plated nut cover. Fits Hug-A-Lug® Part No. 019001.



005014

Wheel Cap Nuts (Fasteners)

60° Cone Seat Cap Nuts (For Stud Located 16" Wheels)

Part No. Single	Part No. Shelf Pack (10)	Thread Size	Torque
005014	005014SP	M14 x 1.5mm, 7/8" hex	100 - 110 ft. lbs.
005916	005916SP	9/16" x 20 tpi, 7/8" hex	120 - 140 ft. lbs.



Each lug nut has specific inner threads for each application with universal outside threads to accept the Alcoa chrome-plated nut cover. Fits Hug-A-Lug® Part Nos. 000078 and 000079.



Howmet Wheel Systems
1616 Harvard Ave.
Cleveland, OH 44105
(800) 242-9898

www.alcoawheels.com